

CH3LNN-32 带过电流保护的剩余电流动作断路器 安装使用说明书
CH3LN-40 GB/T 16917.1
CH3LN-63 Ue 230/400V~
CH3LH-63 IΔn 30mA/100mA/300mA Type AC /A
 Curves C&D
 IP 20

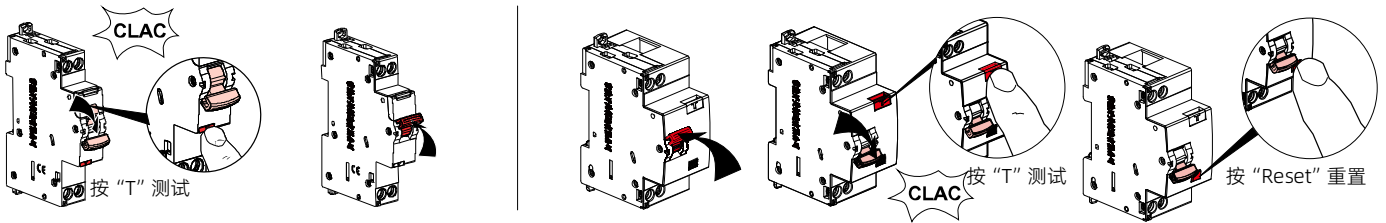

扫描下载

为了确保您的安全，剩余电流保护装置必须定期进行测试。对于此测试周期，若无相关国家规范，常熟开关制造有限公司强烈建议您每月进行一次测试；按下按钮“T”，断路器应被断开。如没有断开，请立即请电工前来处理，因为您的断路器的安全性已降低。即使装备有剩余电流保护装置，也需要遵守与电气使用相关的各项预防措施。



仅当产品处于断开位置时，在底部接线端子进行绝缘测试！

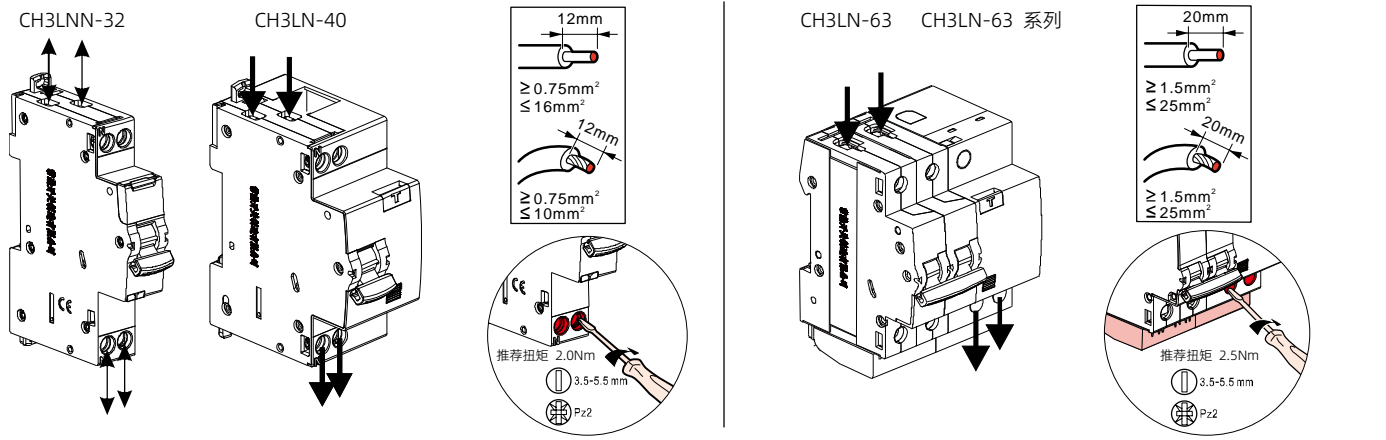
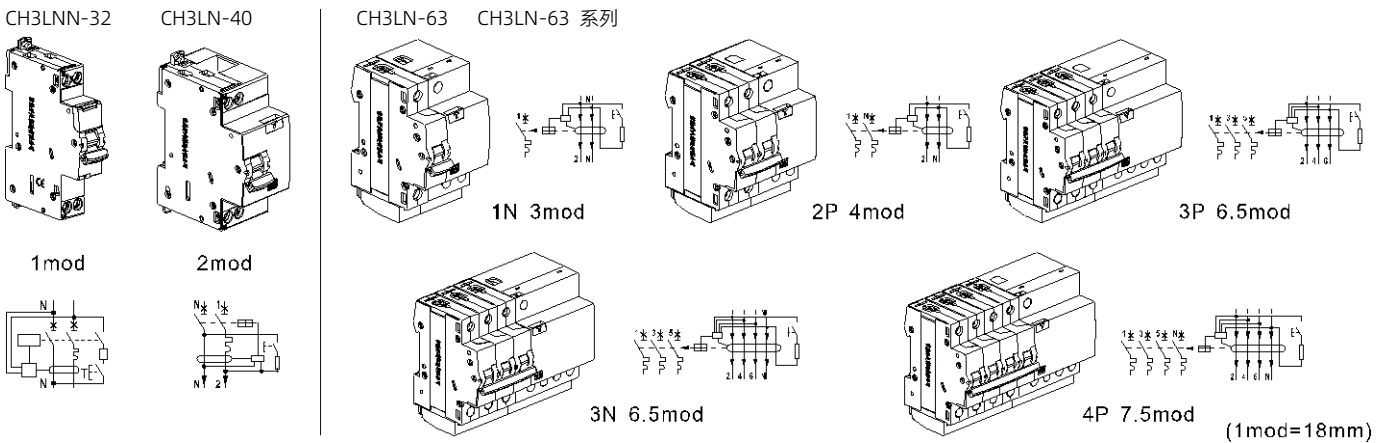

安全规程

本产品必须依照安装规范，最好由拥有相关资质的电工进行安装。不正确的安装和使用将可能导致触电或火灾危险。在进行安装前，请仔细阅读说明书，并应考虑到产品专用安装地点的情况。除非说明书特别注明，否则不得拆开、拆卸或改动设备。常熟开关制造有限公司的任何产品只能由经常熟开关制造有限公司培训并获得相关资质的人员拆开或修理。用户未经许可自行拆开或修理，制造商不负任何责任，同时取消其更换和保修的权利。本产品只能使用常熟开关制造有限公司品牌的配件。

CH3LNN-32 Residual current breaker with overcurrent protection

CH3LN-40

GB/T 16917.1

Ue 230/400V~

CH3LN-63

IΔn 30mA/100mA/300mA Type AC /A

CH3LH-63

Curves C&D

IP 20

Mounting Operation Manual



Scan to download

To ensure your safety, residual current protection devices must be tested regularly. For this test cycle, if there is no any local regulations or guidelines, Changshu Switchgear Mfg. Co., Ltd. strongly recommends that you conduct a test once a month; Press the button "" and the circuit breaker should be disconnected. If it is not disconnected, ask an electrician to deal with it immediately, as the safety of your circuit breaker has been reduced. Even if a residual current protection device is equipped, all precautions related to electrical use need to be observed.

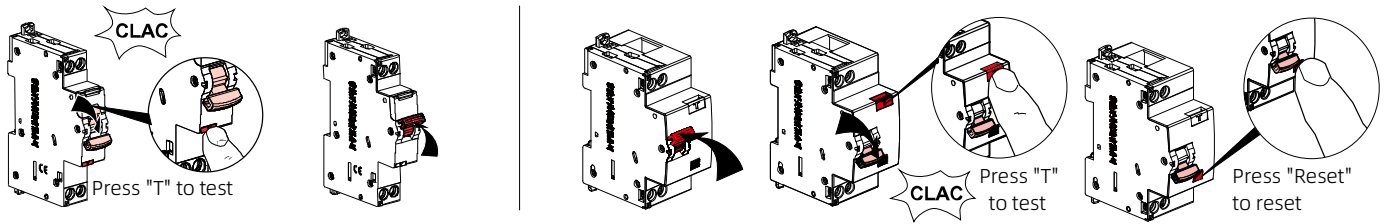

Insulation test at the bottom terminal block only when the product is in the open position!

CH3LNN-32

CH3LN-40

CH3LN-63

CH3LN-63 series

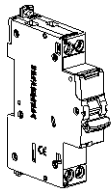

1mod

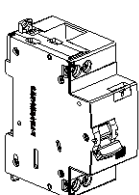
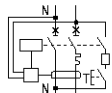

2mod

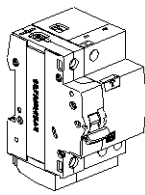
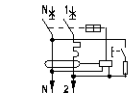

1N 3mod

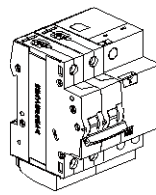
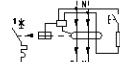

2P 4mod

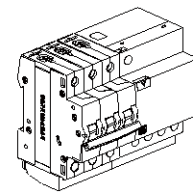
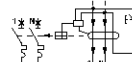

3P 6.5mod

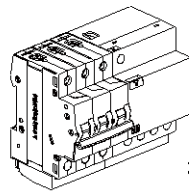
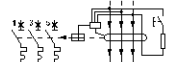

3N 6.5mod

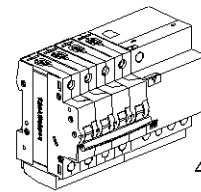
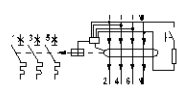

4P 7.5mod

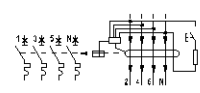

(1mod=18mm)

CH3LNN-32

CH3LN-40

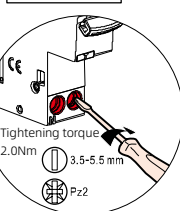
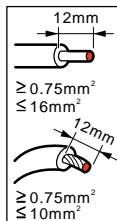
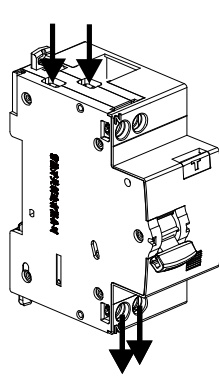
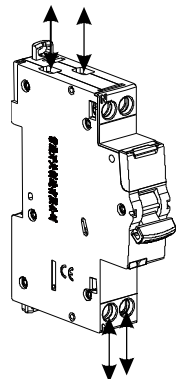

Tightening torque
2.0Nm
3.5-5.5 mm
Pz2

CH3LN-63

CH3LN-63 series

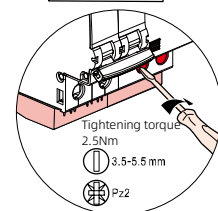
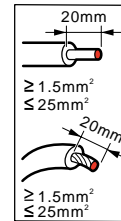
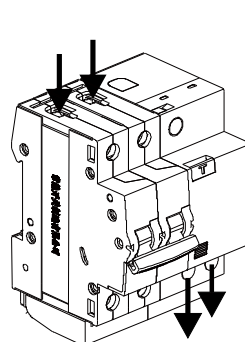

Tightening torque
2.5Nm
3.5-5.5 mm
Pz2

Safety Procedures

This product must be installed in accordance with installation specifications, preferably by a qualified electrician. Incorrect installation and use may result in electric shock or fire hazard. Before installing, please carefully read the instructions and consider the specific installation location for the product. Unless specified in the instruction manual, the equipment shall not be opened, disassembled, or modified. Any product of Changshu Switch Manufacturing Co., Ltd. can only be disassembled or repaired by personnel trained and qualified by Changshu Switch Manufacturing Co., Ltd. The manufacturer shall not be responsible for any unauthorized disassembly or repair by the user, and the right of the users to replace and warranty shall be revoked. This product can only use accessories from Changshu Switch Manufacturing Co., Ltd.