

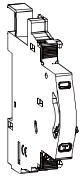

OF3 辅助触头  
SD3 报警触头



MX+OF3 分励脱扣器



G3 过电压保护单元  
Q3A 欠电压保护单元  
GQ3A 过欠压保护单元

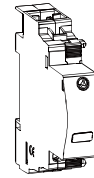

OF3

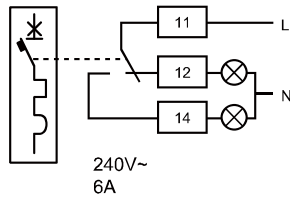
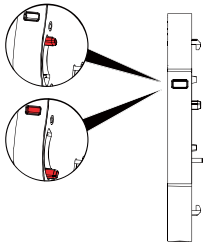

SD3

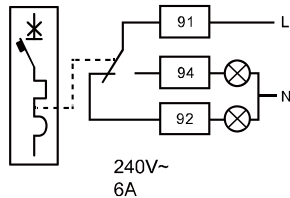
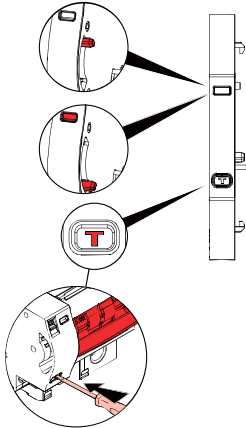

MX+OF3

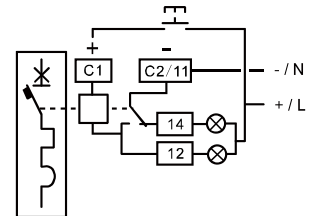
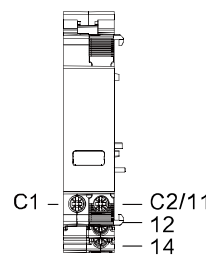

MX+OF3 AC/DC12-48V  
MX+OF3 AC110-415V

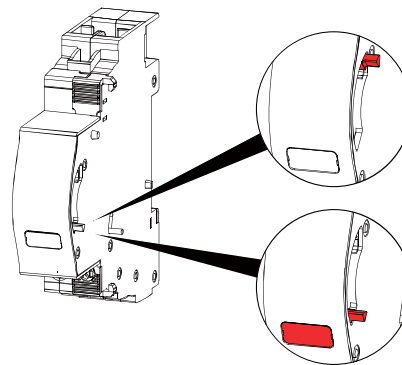

GQ3A

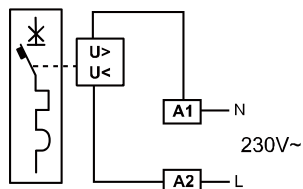
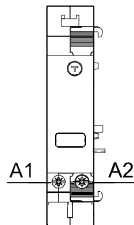

Q3A

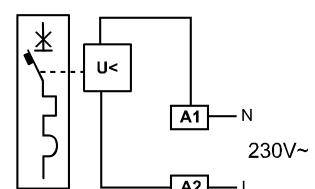
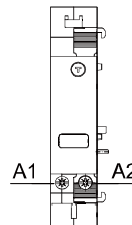

G3

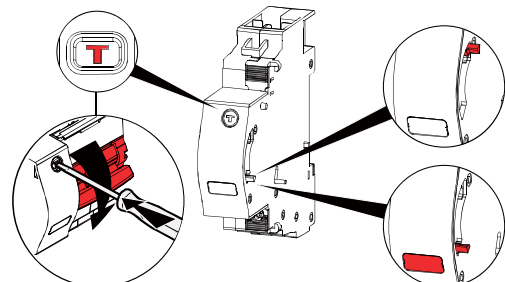
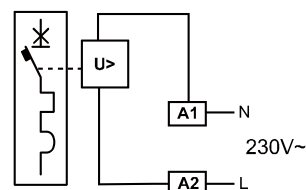
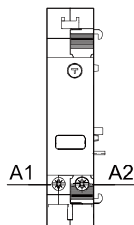

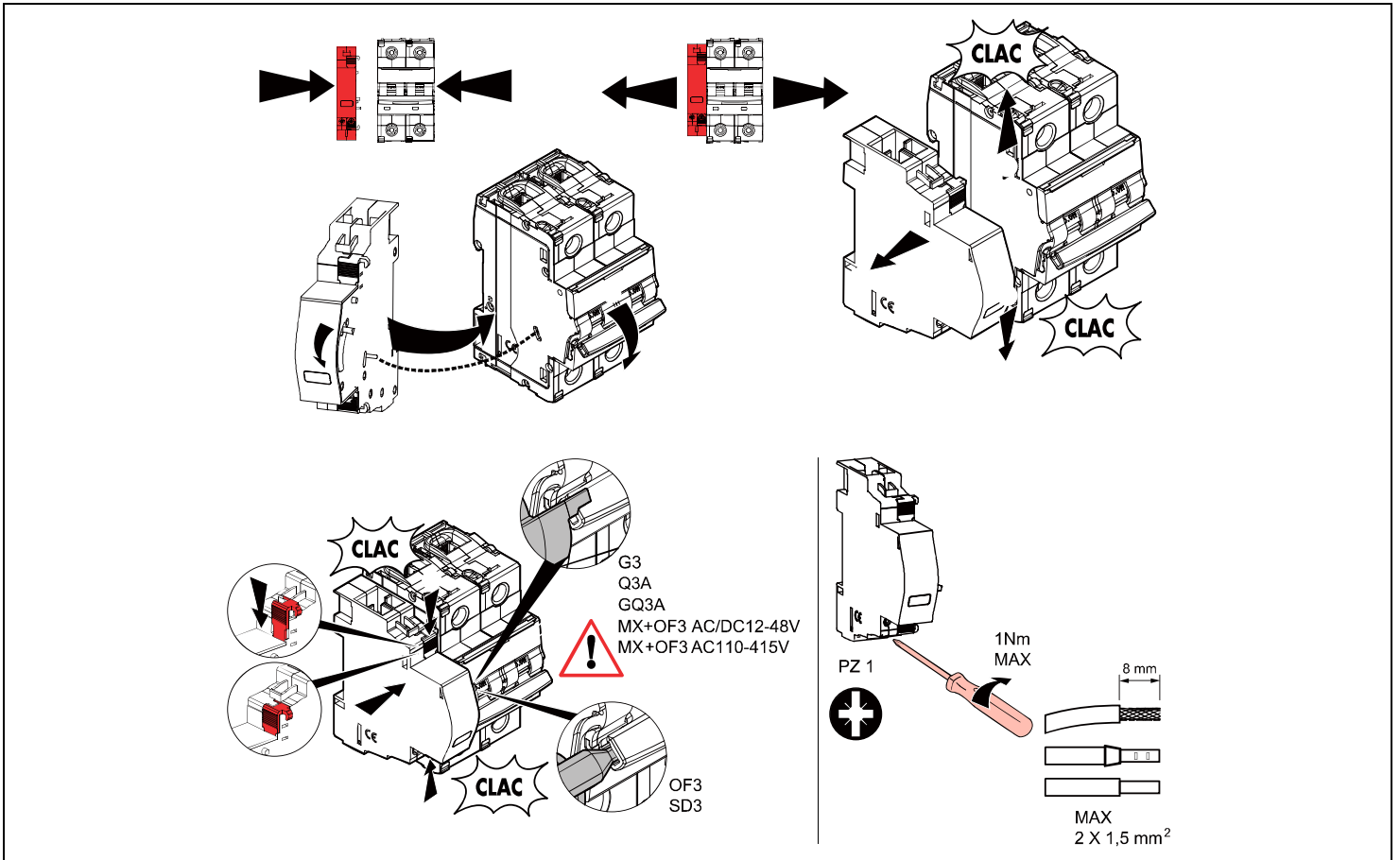

			OF3/SD3/MX+OF3 G3/Q3A/GQ3A
		OF3/SD3/MX+OF3 G3/Q3A/GQ3A	OF3/SD3
	MX+OF3 G3/Q3A/GQ3A	OF3/SD3	OF3/SD3

附件都拼装于左侧。

各产品拼装组合须按下述拼装规则(●: 可拼装; ×: 不可拼装):

	OF3	SD3	MX+OF3	G3	Q3A	GQ3A	FDC3H	LDC3H	最多可拼装附件数
CH3N-40	●	●	●	●	●	●	×	×	3
CH3N-63	●	●	●	●	●	●	●	×	3
CH3H-63	●	●	●	●	●	●	●	●	3(除 LDC3H 外) <sup>*)</sup>
CH3Z-63	●	●	●	●	●	●	●	×	3
CH3H-125	×	×	×	×	×	×	×	×	0
CH3G-125	●	×	×	×	×	×	×	×	2

\*: CH3H-63 在拼装 LDC3H 的情况下, 仍然可按上表最多拼装 3 个其余附件。

## 安全规程

本产品必须依照安装规范, 最好由拥有相关资质的电工进行安装。不正确的安装和使用将可能导致触电或火灾危险。

在进行安装前, 请仔细阅读说明书, 并应考虑到产品专用安装地点的情况。除非说明书特别注明, 否则不得拆开、拆卸或改动设备。常熟开关制造有限公司的任何产品只能由经常熟开关制造有限公司培训并获得相关资质的人员拆开或修理。用户未经许可可自行拆开或修理, 制造商不负任何责任, 同时取消其更换和保修的权利。

本产品只能使用常熟开关制造有限公司品牌的配件。



Scan to Download

**OF3 Auxiliary contact  
SD3 Alarm contact**



**MX+OF3 Shunt release**



**G3 Overvoltage release  
Q3A Undervoltage release  
GQ3A Undervoltage & overvoltage release**

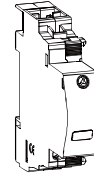

**OF3**

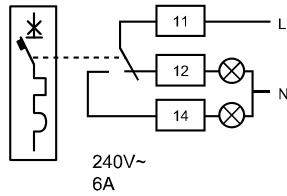
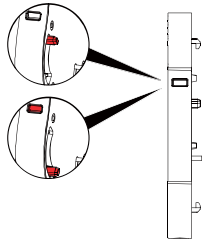

**SD3**

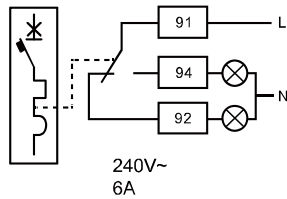
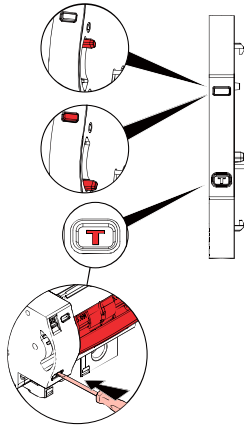

**MX+OF3**

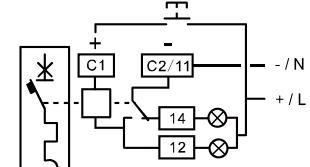
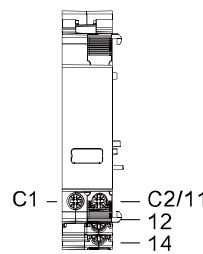

**MX+OF3 AC/DC12-48V  
MX+OF3 AC110-415V**

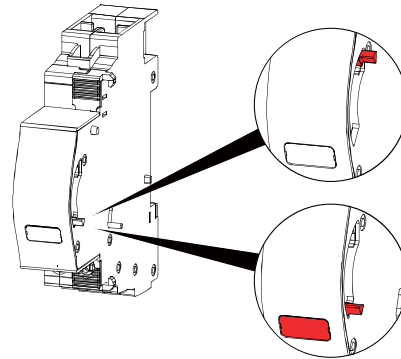

**GQ3A**

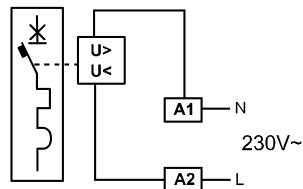
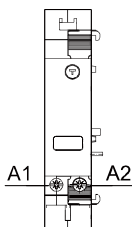



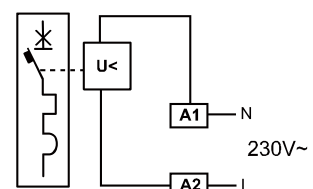
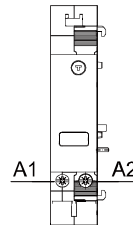

**Q3A**

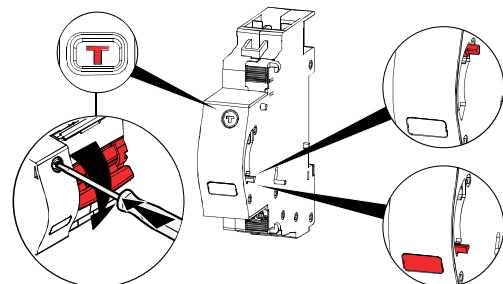
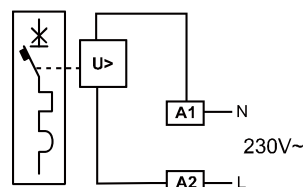
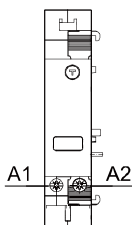

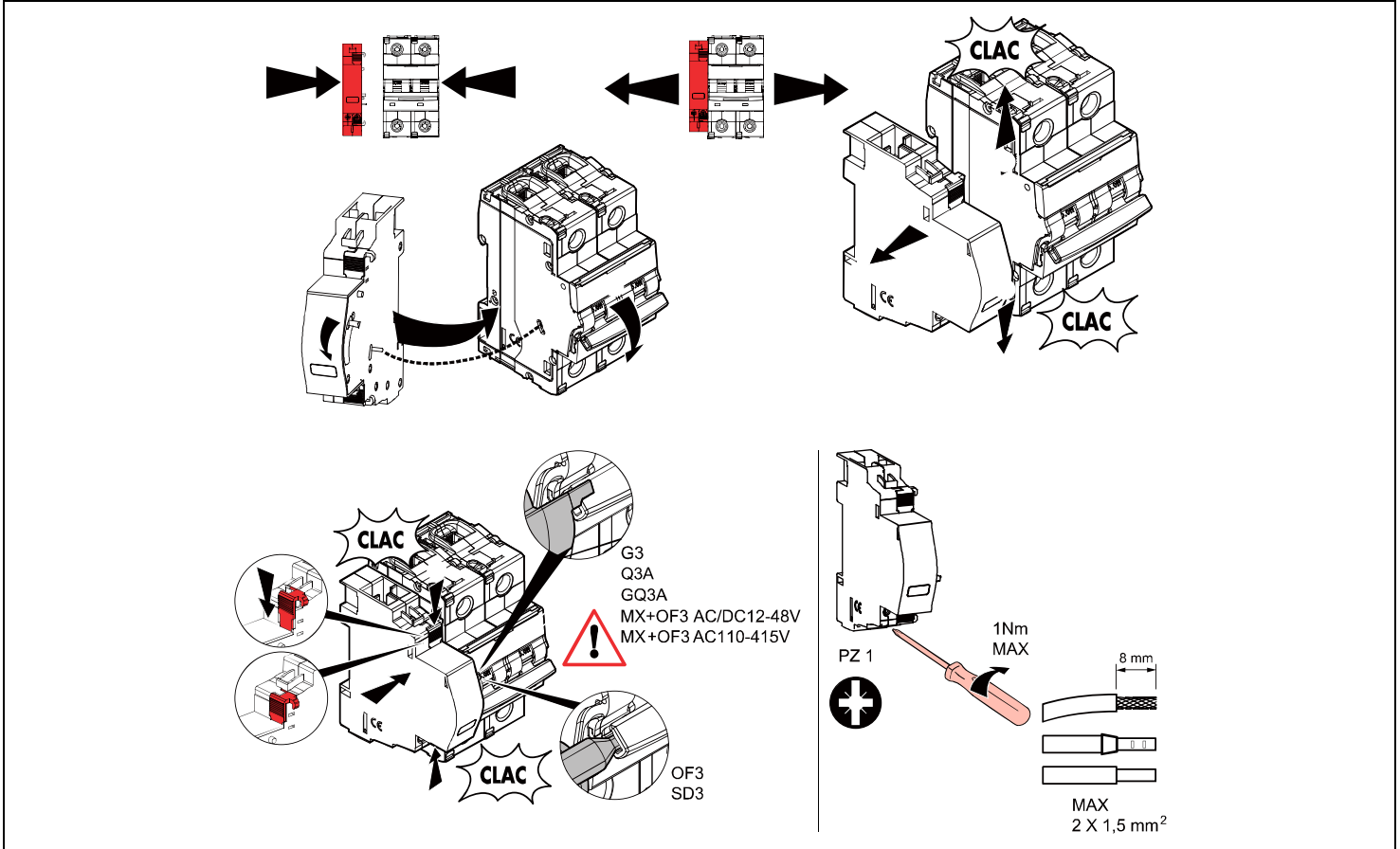
**G3**

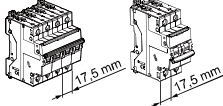
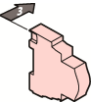
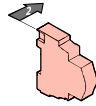
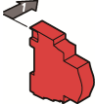

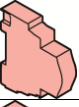

			
			OF3/SD3/MX+OF3 G3/Q3A/GQ3A
		OF3/SD3/MX+OF3 G3/Q3A/GQ3A	OF3/SD3
	MX+OF3 G3/Q3A/GQ3A	OF3/SD3	OF3/SD3

Auxiliaries are clipped on the left of the products.

Possible combinations with auxiliaries (●:It can be combined; ×:It can't be combined):

	OF3	SD3	MX+OF3	G3	Q3A	GQ3A	FDC3H	LDC3H	Max number
CH3N-40	●	●	●	●	●	●	×	×	3
CH3N-63	●	●	●	●	●	●	●	×	3
CH3H-63	●	●	●	●	●	●	●	●	3(Excluding LDC3H) <sup>1)</sup>
CH3TMH-63	●	●	●	●	●	●	●	×	3
CH3Z-63	●	●	●	●	●	●	●	×	3
CH3H-125	×	×	×	×	×	×	×	×	0
CH3G-125	●	×	×	×	×	×	×	×	2

\* After the CH3H-63 is combined with LDC3H, the rest of the auxiliaries can still be combined according to the table above.

### Safety Procedures

This product must be installed in accordance with installation specifications, preferably by a qualified electrician. Incorrect installation and use may result in electric shock or fire hazard. Before installing, please carefully read the instructions and consider the specific installation location for the product. Unless specified in the instruction manual, the equipment shall not be opened, disassembled, or modified. Any product of Changshu Switch Manufacturing Co., Ltd. can only be disassembled or repaired by personnel trained and qualified by Changshu Switch Manufacturing Co., Ltd. The manufacturer shall not be responsible for any unauthorized disassembly or repair by the user, and the right of the users to replace and warranty shall be revoked. This product can only use accessories from Changshu Switch Manufacturing Co., Ltd.